

# Pump series MPN magnetically coupled centrifugal pump

Original operating manual

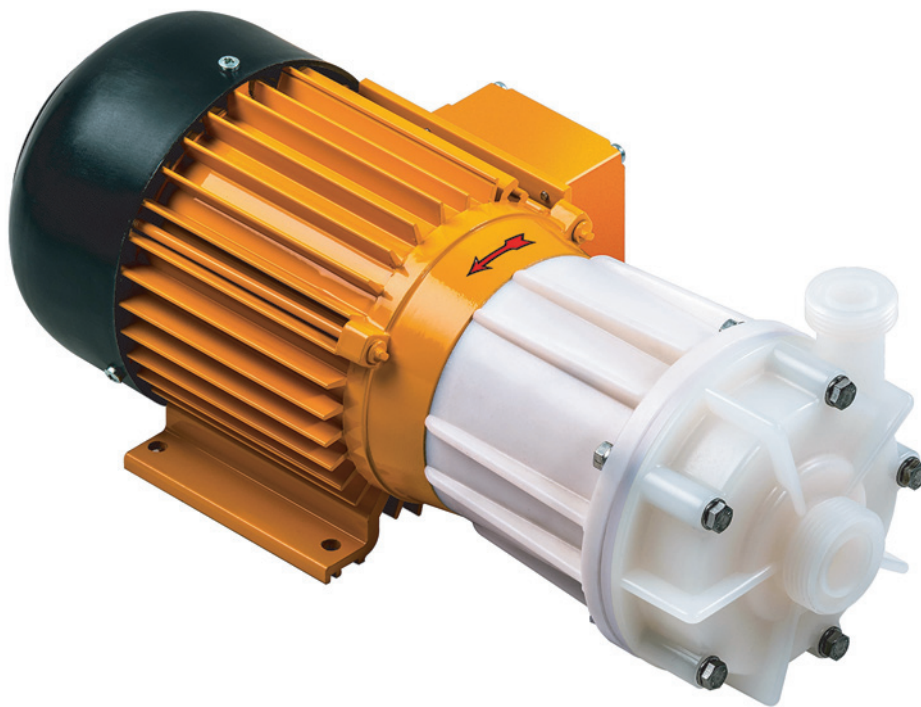

Version 11333/0325  
Print-No.

SCHMITT-Kreiselpumpen GmbH & Co. KG  
Einsteinstraße 33  
76275 Ettlingen  
Germany  
Phone: + 49 (0) 7243 / 54 53 - 0  
E-Mail: [sales@schmitt-pumpen.de](mailto:sales@schmitt-pumpen.de)  
Internet: [www.schmitt-pumpen.de](http://www.schmitt-pumpen.de)

Subject to technical modifications.

Read carefully before use.  
Save for future use.



# Table of contents

<b>1 About this document</b>	4	5.4.3 Installing the pressure pipe	13
1.1 Target groups	4	5.4.4 Inspection for stress-free pipe connections	13
1.2 Other applicable documents	4	5.5 Electrical connection	14
1.3 Warnings and symbols	5	5.5.1 Connecting the motor	14
<b>2 General safety instructions</b>	6	5.5.2 Check direction of rotation	14
2.1 Intended use	6	<b>6 Operation</b>	15
2.2 General safety instructions	6	6.1 Preparing for commissioning	15
2.2.1 Product safety	6	6.1.1 Check downtimes	15
2.2.2 Obligations of the operating company	7	6.1.2 Filling and bleeding	15
2.2.3 Obligations of personnel	7	6.1.3 Check direction of rotation	15
2.3 Specific hazards	7	6.2 Commissioning	15
2.3.1 Potentially explosive atmospheres	7	6.2.1 Switching on	15
2.3.2 Electric shock	7	6.2.2 Switching off	15
2.3.3 Hazardous pumped media sprayed out	8	6.3 Shutting down the pump	16
2.3.4 Moving parts	8	6.4 Restoring the pump to service	16
2.3.5 Hot surfaces	8	6.5 Operating the stand-by pump	16
2.3.6 Magnetic field	8	<b>7 Maintenance</b>	17
<b>3 Layout and Function</b>	9	7.1 Inspections	17
3.1 Marking	9	7.2 Servicing	17
3.1.1 Name plate	9	7.2.1 Maintenance in accordance with maintenance schedule	17
3.1.2 ATEX type plate	9	7.2.2 Changing the plain bearings	17
3.2 Description	10	7.2.3 Cleaning the pump	18
3.3 Assembly	10	7.3 Dismounting	18
3.4 Magnetic coupling	10	7.3.1 Preparations for dismounting	18
<b>4 Transport, Storage and Disposal</b>	11	7.3.2 Dismount the pump	19
4.1 Transport	11	7.4 Replacement parts and return	19
4.1.1 Unpacking and inspection on delivery	11	7.5 Installing	20
4.1.2 Lifting	11	7.5.1 Preparations for installation	20
4.2 Storage	11	7.5.2 Assembly of the pump	20
4.3 Disposal	11	7.5.3 Install the pump into the system	21
<b>5 Installation and connection</b>	12	<b>8 Troubleshooting</b>	22
5.1 Preparing for installation	12	<b>9 Appendix</b>	25
5.1.1 Check operating conditions	12	9.1 Replacement parts	25
5.1.2 Preparing the installation site	12	9.1.1 Part numbers and designations	25
5.1.3 Surface preparation	12	9.1.2 Drawing	26
5.2 Setting up	12	9.2 Technical specifications	27
5.3 Planning pipelines	12	9.2.1 Ambient conditions	27
5.3.1 Designing pipelines	12	9.2.2 Total pressure	27
5.3.2 Arranging the supports and connections	12	9.2.3 Wear limits	27
5.3.3 Specifying nominal widths	12	9.2.4 Installation dimensions	28
5.3.4 Specifying pipe lengths	13	9.2.5 Sound pressure level	28
5.3.5 Optimizing changes of cross section and direction	13	9.2.6 Tightening torques of casing screws	28
5.3.6 Providing safety and control devices (recommended)	13	9.2.7 Flow rate, delivery head and minimum flow rate	29
5.4 Connecting the pipes	13	9.2.8 Weight	29
5.4.1 Keeping the piping clean	13	9.2.9 Cleaning agents	29
5.4.2 Installing suction pipe	13	9.3 Maintenance schedule	30
		9.4 Declaration of conformity in accordance with EC machinery directive	31

## List of figures

Fig. 1	Name plate (example) .....	9
Fig. 2	ATEX type plate (example) .....	9
Fig. 3	MPN layout .....	10
Fig. 4	Attach the lifting gear to the modular pump (illustration of general principle) .....	11
Fig. 5	Straight pipe lengths in front and after the pumps (recommended) .....	13
Fig. 6	Parts .....	26
Fig. 7	Total pressure, pump head material PP .....	27
Fig. 8	Total pressure, pump head material PVDF .....	27
Fig. 9	Wear limits for the large angle ring (12v), housing end .....	27
Fig. 10	Wear limits for the small angle ring (11h), rear cover end .....	27
Fig. 11	Installation dimensions .....	28

## List of tables

Tab. 1	Other application documents, purpose and where found .....	4
Tab. 2	Warning signs and consequences if disregarded .....	5
Tab. 3	Symbols and their meaning .....	5
Tab. 4	Measures to be taken if the pump is shut down .....	16
Tab. 5	Measures depending on the behavior of the pumped liquid .....	16
Tab. 6	Fault/number assignment .....	22
Tab. 7	Troubleshooting list .....	24
Tab. 8	Designation of components according to part numbers .....	25
Tab. 9	Ambient conditions .....	27
Tab. 10	Wear limits for the large angle ring, housing end .....	27
Tab. 11	Wear limits for the small angle ring, rear cover end .....	28
Tab. 12	Installation dimensions .....	28
Tab. 13	Sound pressure level .....	28
Tab. 14	Tightening torques of casing screws .....	28
Tab. 15	Flow rate, delivery head and minimum flow rate .....	29
Tab. 16	Weight .....	29
Tab. 17	Maintenance schedule .....	30

# 1 About this document

This manual:

- is an integral part of the pump
- applies to all series referred to
- describes safe and proper operation during all operating phases

## 1.1 Target groups

### Operating company

- Responsibilities:
  - Always keep this manual accessible where the device is used on the system.
  - Ensure that employees read and observe this document, particularly the safety instructions and warnings, and the documents which also apply.
  - Observe any additional country-specific rules and regulations that relate to the system.

### Qualified personnel, fitter





- Mechanics qualification:
  - Qualified employees with additional training for fitting the respective pipework
- Electrical qualification:
  - Qualified electrician
- Transport qualification:
  - Qualified transport specialist
- Responsibility:
  - Read, observe and follow this manual and the other applicable documents, especially all safety instructions and warnings.

## 1.2 Other applicable documents



Document/purpose	Where found
The following documents are available online: <ul style="list-style-type: none"> <li>• ATEX additional instructions</li> <li>• Resistance lists               <ul style="list-style-type: none"> <li>– Resistance of materials used to chemicals</li> </ul> </li> <li>• Data sheet               <ul style="list-style-type: none"> <li>– Technical specifications, operating conditions, dimensions</li> </ul> </li> <li>• <a href="http://www.schmitt-pumpen.de/en/services/downloads">www.schmitt-pumpen.de/en/services/downloads</a></li> </ul>	
Spare parts list <ul style="list-style-type: none"> <li>• Ordering spare parts</li> </ul>	Documentation included
Sectional drawing <ul style="list-style-type: none"> <li>• Sectional drawing, part numbers, component designations</li> </ul>	
Documentation for the drive <ul style="list-style-type: none"> <li>• Technical documentation for drives</li> </ul>	
Declaration of conformity <ul style="list-style-type: none"> <li>• Conformity with standards</li> <li>• (→ 9.4 Declaration of conformity in accordance with EC machinery directive, Page 31).</li> </ul>	

Tab. 1 Other application documents, purpose and where found

### 1.3 Warnings and symbols

Warning sign	Level of risk	Consequences if disregarded
	immediate acute risk	Death, serious bodily harm
	potentially acute risk	Death, serious bodily harm
	potentially hazardous situation	Minor injury
	potentially hazardous situation	Material damage

Tab. 2 Warning signs and consequences if disregarded

Symbol	Meaning
	Safety warning sign ▶ Take note of all information highlighted by the safety warning sign and follow the instructions to avoid injury or death.
▶	Instruction
1., 2., ...	Multiple-step instructions
✓	Precondition
→	Cross reference
	Information, notes

Tab. 3 Symbols and their meaning

## 2 General safety instructions

 The manufacturer accepts no liability for damages caused by disregarding any of the documentation.

### 2.1 Intended use

- Only use the pump with suitable media. Pump parts in contact with media must be resistant to the media. (→ Order specification).
- Use the pump for flammable or explosive media only if it is intended for use in potentially explosive atmospheres (→ATEX additional instructions).
- Adhere to the operating limits and size-dependent minimum flow rates.
- Avoid dry running:  
Initial damage, such as destruction of plain bearings, seals and plastic parts, will occur within a few seconds.
  - Make sure the pump is only operated only when filled with the conveyed fluid and vented, and never operated when not filled with the pumped liquid.
  - Ensure that there are no excessively high amounts of gas in the pumping medium.
  - Ensure that the pump is operated only within the permissible operating range.
  - Ensure that the use of shut-off valves or filters does not cause the pressure on the inlet side of the pump to be too low.
- Avoid cavitation:
  - Open the suction-side fitting and do not use it to regulate the flow.
  - Do not open the pressure-side fitting beyond the agreed operating point.
- Avoid overheating:
  - Do not operate the pump while the pressure-side fitting is closed.
  - Observe the minimum flow rate (→ 9.2 Technical specifications, Page 27).
- Avoid damage to the motor:
  - Do not open the pressure-side fitting beyond the agreed operating point.
  - Note the maximum permissible number of times the motor can be switched on per hour (→ manufacturer's specifications).
- Consult with the manufacturer regarding any other use of the device.

### Prevention of obvious misuse (examples)

- Observe pump limits of use regarding temperature, pressure, flow and speed (→ 9.2 Technical specifications, Page 27).
- The power consumption of the pump increases as the specific gravity of the pumped fluid increases. Adhere to the permissible specific gravity in order to eliminate the possibility that the pump and motor become overloaded (→ 9.2 Technical specifications, Page 27).  
A lower specific gravity is permissible. Adapt the auxiliary systems accordingly.
- When conveying fluids containing solids, observe the limit values for proportions of solid particles and particle size:
  - Particle size  $\leq 3$  mm
  - Proportion of solid particles  $\leq 10$  % Vol.
- The type of installation should be selected only in accordance with these operating instructions. For example, the following are not allowed:
  - Hanging pumps in the pipe
  - Overhead installation
  - Installation in the immediate vicinity of extreme heat or cold sources
  - Installation too close to a wall
  - Vertical installation

## 2.2 General safety instructions

 Observe the following regulations before carrying out any work.

### 2.2.1 Product safety

The pump has been built according to state-of-the-art technology and the recognized technical safety regulations. Nevertheless, operation of the pump can still put the life and health of the user or third parties at risk or damage the pump or other property.

- Operate the pump only if it is in perfect technical condition and use it only as intended, staying aware of safety and risks, and in adherence to the instructions in this manual.
- Keep this manual and all other applicable documents complete, legible and accessible to personnel at all times.
- Refrain from any procedures and actions that would pose a risk to personnel or third parties.
- In the event of any safety-relevant faults, shut down the pump immediately and have the fault corrected by appropriate personnel.
- In addition to the entire documentation for the product, comply with statutory or other safety and accident-prevention regulations and the applicable standards and guidelines in the country where the pump is operated.

## 2.2.2 Obligations of the operating company

### Safety-conscious working

- Operate the pump only if it is in perfect technical condition and use it only as intended, staying aware of safety and risks, and in adherence to the instructions in this manual.
- Ensure that the following safety aspects are observed and monitored:
  - Intended use
  - Statutory or other safety and accident-prevention regulations
  - Safety regulations governing the handling of hazardous substances
  - Applicable standards and guidelines in the country where the pump is operated
  - Applicable guidelines of the operator
- Make personal protective equipment available.

### Qualified personnel

- Make sure all personnel tasked with work on the pump have read and understood this manual and all other applicable documents, especially the safety, maintenance and repair information, before they start any work.
- Organize responsibilities, areas of competence and the supervision of personnel.
- Make sure that trainee personnel only work on the pump under supervision of specialist technicians.
- All activities may be carried out only by specialists who hold the required qualifications:

Actions	Required qualified personnel
Mechanical work (installation, maintenance, servicing)	Skilled mechanic
Electrical work (electrical installation)	Qualified electrician
All further work	Instruction by the user/owner

### Safety equipment

- Provide the following safety equipment and verify its functionality:
  - For hot, cold and moving parts: pump safety guarding provided by the customer
  - For pumps without capability to run dry: Dry run protection

### Warranty

- Obtain the manufacturer's approval prior to carrying out any modifications, repairs or alterations during the warranty period.
- Only use genuine parts or parts that have been approved by the manufacturer.

## 2.2.3 Obligations of personnel

- All directions given on the pump must be followed (and kept legible), e.g. the arrow indicating the sense of rotation and the markings for fluid connections.
- Pump, coupling guard and components:
  - Do not step on them or use as a climbing aid
  - Do not use them to support boards, ramps or beams
  - Do not use them as a fixing point for winches or supports
  - Do not use them for storing paper or similar materials
- Do not remove the safety guarding for hot, cold or moving parts during operation.
- If necessary, use protective equipment for the specific application:
  - Helmet
  - Safety gloves
  - Safety goggles
  - Gloves
  - Further protective equipment depending on the medium being pumped
- Only carry out work on the pump while it is not running.
- Before all installation and maintenance work, disconnect the motor from the mains and secure it against being switched back on again.
- Never reach into the suction or discharge flange.
- Following all work on the pump, refit safety devices in accordance with the instructions and bring into service.
- Do not make any modifications to the device.

## 2.3 Specific hazards

### 2.3.1 Potentially explosive atmospheres

Observe ATEX additional manual

- Additional instructions for use in explosive atmospheres
- (→ [www.schmitt-pumpen.de/sites/default/files/2020-10/ATEX-Zusatzanleitung-en.pdf](http://www.schmitt-pumpen.de/sites/default/files/2020-10/ATEX-Zusatzanleitung-en.pdf))



### 2.3.2 Electric shock

In the event of contact with live parts (e.g. wires in the terminal box of the electric motor), there is a risk of electric shock resulting in serious injury or death.

- All electrical work must be carried out by qualified electricians only.
- Before all work on the electrical system, disconnect the motor from the mains and secure against being switched back on again.

### 2.3.3 Hazardous pumped media sprayed out

Pumped media can be toxic and hot and can be sprayed out. In the event of contact, there is a risk of burns and skin rashes.

- When handling hazardous fluids (e.g. hot, flammable, explosive, toxic, hazardous to health or the environment), observe the safety regulations for the handling of hazardous substances.
- Allow the pump to cool completely before commencing any work and then depressurize it.
- Use protective equipment for any work on the pump.
- Empty the pump during maintenance and repair work.
- Safely collect the fluid and dispose of it in accordance with environmental regulations.

### 2.3.4 Moving parts

Moving parts (e.g. shaft, impeller, coupling) present a risk of fatal injury due to being dragged in, crushed or trapped.

- Do not touch the pump when it is running.
- Do not carry out any work on the pump when it is running.
- Maintain an adequate distance from moving parts.
- When performing installation and maintenance work, disconnect the motor from the mains and secure it against being switched back on again.
- (If present) ensure contact guard is fitted after work on the pump.

### 2.3.5 Hot surfaces

During operation, high temperatures are generated on the surfaces of the housing. Even after switching off, the surfaces of the housing can still be hot and can cool down only slowly. There is a risk of burns when touching hot surfaces.

- Do not touch the pump when it is running.
- Allow the pump to cool completely before commencing any work.
- Wear protective gloves.

### 2.3.6 Magnetic field

The magnetic field of the magnetic coupling can destroy products and devices that are sensitive to magnets. These include electronic implants (such as pacemakers), digital watches, calculators, hard drives, credit cards and ID cards. For persons with electronic implants there is a danger to life.

- Do not allow persons with electronic implants to work on the pump or on magnetic parts.
- Secure the work place and if necessary cordon off:
  - Ensure that persons with electronic implants maintain a safe distance > 1 m
  - Make sure that no magnetizable metal parts are attracted by the pump's magnetic coupling.
  - Make sure that parts of the magnetic coupling are not attracted by the magnetizable metal parts
- Keep magnetizable objects a safe distance > of 150 mm away from the magnetic coupling.

## 3 Layout and Function

### 3.1 Marking

#### 3.1.1 Name plate

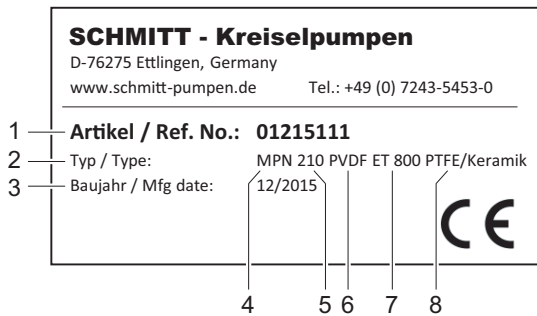

Fig. 1 Name plate (example)

- 1 Article numbers
- 2 Type
- 3 Year of manufacture (month/year)
- 4 Pump series
- 5 Size
- 6 Pump material
- 7 Immersion depth
- 8 Version

#### 3.1.2 ATEX type plate



Fig. 2 ATEX type plate (example)

- 1 Explosion protection label

### 3.2 Description

Non self-priming and magnetically coupled centrifugal pump in modular design:

- Media-lubricated plain bearings
- Horizontal installation
- Direction of conveying
  - Suction flange, axial
  - Discharge flange, vertical

### 3.3 Assembly

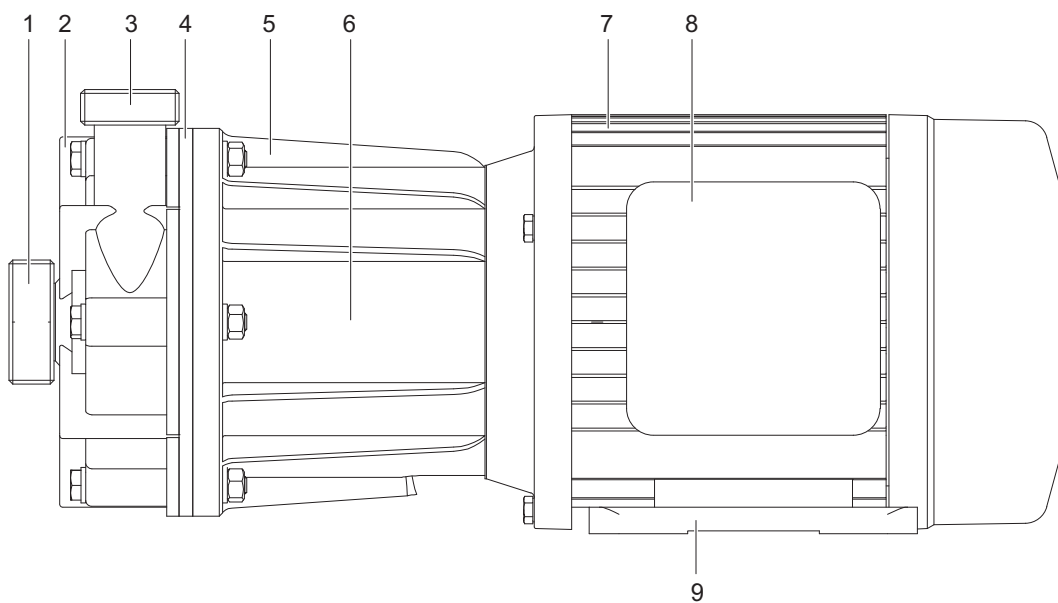

Fig. 3 MPN layout

- |                    |                              |                |
|--------------------|------------------------------|----------------|
| 1 Suction branch   | 4 Rear cover                 | 7 Motor        |
| 2 Housing          | 5 Pump support               | 8 Terminal box |
| 3 Discharge flange | 6 Magnetic coupling (hidden) | 9 Motor foot   |

### 3.4 Magnetic coupling

Pumps with magnetic couplings are hermetically sealed and leaktight. Power transmission from the motor is non-contact through an enclosed and hermetically sealed rear cover on the impeller.

## 4 Transport, Storage and Disposal

### 4.1 Transport

 The user/owner is responsible for the transport of the pump.

 Weight specification (→ 9.2 Technical specifications, Page 27).

#### 4.1.1 Unpacking and inspection on delivery

1. Unpack the pump/machine drive on delivery, and inspect it for transport damage.
2. Check completeness and accuracy of delivery.
3. Ensure that the information on the name plate agrees with the order/design data.
4. Report any transportation damage to the manufacturer immediately.
5. Dispose of packaging material according to local regulations.

#### 4.1.2 Lifting

### DANGER

**Death or limbs crushed as a result transported items falling over!**

- ▶ Use lifting gear appropriate for the total weight to be transported.
- ▶ Attach lifting gear in accordance with the following diagram.
- ▶ Do not stand under suspended loads.

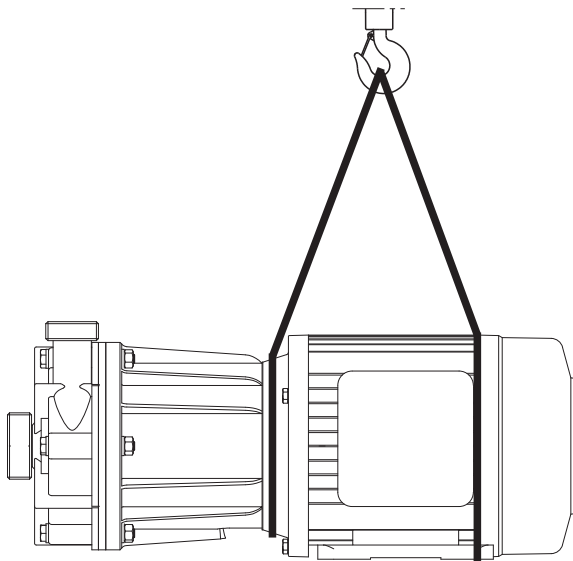

Fig. 4 Attach the lifting gear to the modular pump (illustration of general principle)

1. Attach lifting gear in accordance with the above diagram.

2. Lift the modular pump appropriately.

### 4.2 Storage

#### NOTE

**Material damage due to inappropriate storage!**

- ▶ Store the pump properly.

1. Seal all openings with blind plugs or plastic covers.
2. Make sure the storage room meets the following conditions:
  - Dry
  - Frost-free
  - Vibration-free
  - UV protected
3. Rotate the pump shaft twice a month.
4. Make sure the shaft and bearing change their rotational position in the process.

### 4.3 Disposal

 Plastic parts can be contaminated by poisonous or radioactive pumped liquids to such an extent that cleaning will be insufficient.

### WARNING

**Risk of poisoning and environmental damage by the pumped liquid!**

- ▶ Use personal protective equipment when carrying out any work on the pump.
  - ▶ Prior to the disposal of the pump:
    - Collect and damage any escaping pumped liquid in accordance with local regulations.
    - Neutralize residues of pumped liquid in the pump.
  - ▶ Remove plastic parts and damage them in accordance with local regulations.
- 
- ▶ Dispose of the pump in accordance with local regulations.

## 5 Installation and connection

 For pumps in potentially explosive atmospheres (→ ATEX additional manual).

---

### NOTE

---

#### Material damage caused by dirt!

- ▶ Do not remove the transport seals until immediately before installing the pump.
- ▶ Do not remove any covers or transport and sealing covers until immediately before connecting the pipes to the pump.

### 5.1 Preparing for installation

#### 5.1.1 Check operating conditions

- ▶ Ensure the required operating conditions are met:
  - Resistance of body and seal material to the medium (→ resistance lists).
  - Required ambient conditions (→ 9.2.1 Ambient conditions, Page 27).

#### 5.1.2 Preparing the installation site

- ▶ Ensure the installation site meets the following conditions:
  - Pump is freely accessible from all sides
  - Sufficient space for the installation/removal of the pipes and for maintenance and repair work, especially for the removal and installation of the pump
  - Pump not exposed to external vibration (damage to bearings)
  - Pump not exposed to external corrosive influences
  - Frost protection

#### 5.1.3 Surface preparation

- ✓ Aids, tools, materials:
  - Spirit level
- ▶ Make sure the surface meets the following conditions:
  - Level and horizontal
  - Clean (no oil, dust or other impurities)
  - Capable of bearing the weight of the machine drive and all operating forces
  - Ensures the stability of the machine drive

### 5.2 Setting up

1. Lift up the machine drive (→ 4.1 Transport, Page 11).
2. Put down the machine drive at the place of installation.
3. Screw the attachment bolts into the motor foot and tighten them.

### 5.3 Planning pipelines

 Water hammer may damage the pump or the system. Plan the pipes and fittings as far as possible to prevent water hammer occurring.

#### 5.3.1 Designing pipelines

- ▶ Plan pipes safely:
  - No pulling or thrusting forces
  - No bending moments
  - Adjust for changes in length due to temperature changes (compensators, expansion shanks)
  - Avoid bends close to the suction flange

#### 5.3.2 Arranging the supports and connections

---

### NOTE

---

#### Material damage due to excessive forces and torques on the pump!

- ▶ Ensure pipe connection without stress.

1. Support pipes in front of the pump.
2. Ensure the pipe supports will always allow expansion and contraction of the pipes.

#### 5.3.3 Specifying nominal widths

 Keep the flow resistance in the pipes as low as possible.

1. Make sure the nominal suction line width is not smaller than the nominal suction flange width.
2. Make sure the nominal pressure line width is not smaller than the nominal discharge flange width.

### 5.3.4 Specifying pipe lengths

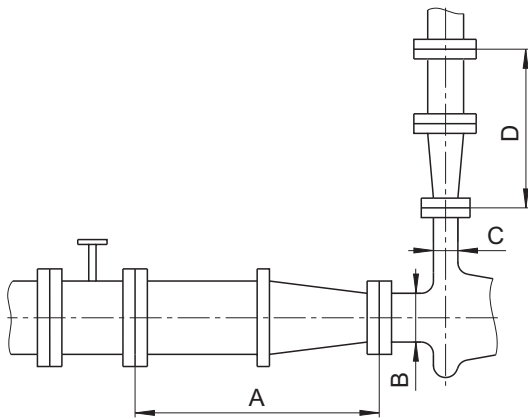

Fig. 5 Straight pipe lengths in front and after the pumps (recommended)

- A > 5x DN<sub>s</sub>
- B DN<sub>s</sub>
- C DN<sub>d</sub>
- D > 5x DN<sub>d</sub>

- ▶ Observe recommended minimum values when installing the pump.

- Suction side: Shorter lengths are possible, but may limit hydraulic performance data.
- Pressure side: Shorter lengths are possible, but may result in increased noise development.

### 5.3.5 Optimizing changes of cross section and direction

1. Avoid radii of curvature of less than 1.5 times the nominal pipe diameter.
2. Avoid abrupt changes of cross-section along the piping.

### 5.3.6 Providing safety and control devices (recommended)

#### Avoid contamination

1. Install a dirt strainer with mesh size < 3 mm in the suction pipe.
2. Install a differential pressure gauge with contact manometer to monitor contamination.

#### Avoid reverse running

1. Install a non-return valve between the discharge flange and stop valve, to ensure that the medium does not flow back after the pump is switched off.
2. In order to enable venting, include vent connection between discharge flanges and non-return valve.

### Make provisions for isolating and shutting off the pipes

- For maintenance and repair work.

- ▶ Provide shut-off devices in the suction pipe and pressure line.

### Dry run protection by measuring the operating conditions

- ▶ Provide monitoring sensors for both pressure and flow rate, to protect the pump against dry running and consequential damage.

## 5.4 Connecting the pipes

### NOTE

#### Material damage due to excessive forces and torques on the pump!

- ▶ Ensure pipe connection without stress.

### 5.4.1 Keeping the piping clean

### NOTE

#### Material damage due to impurities in the pump!

- ▶ Make sure no impurities can enter the pump.

- ▶ Clean all piping parts and fittings prior to assembly.

### 5.4.2 Installing suction pipe

1. Remove the transport and sealing covers from the pump.
2. Fit suction pipe stress-free and sealed.

### 5.4.3 Installing the pressure pipe

1. Remove the transport and sealing covers from the pump.
2. Position the pressure flange facing upwards, so as to allow the pump head to be vented.
3. Fit the pressure line stress-free and sealed.

### 5.4.4 Inspection for stress-free pipe connections

- ✓ Piping installed and cooled down

  1. Disconnect the pipe connections from the pump.
  2. Check whether the pipes can be moved freely in all directions within the expected range of expansion.
  3. Make sure that the connections are parallel.
  4. Reconnect the pipe connections to the pump.

## 5.5 Electrical connection

### **DANGER**

#### **Risk of electrocution!**

- ▶ All electrical work must be carried out by qualified electricians only.
- ▶ Before all work on the electrical system, disconnect the motor from the mains and secure against being switched back on again.

---

#### **5.5.1 Connecting the motor**

 Follow the instructions of the motor manufacturer.

1. Connect the motor according to the connection diagram.
2. Make sure no danger arises due to electric power.
3. Install an EMERGENCY STOP switch.

#### **5.5.2 Check direction of rotation**

 Only possible when starting up ([→ 6.2 Commissioning, Page 15](#)).

## 6 Operation

 For pumps in potentially explosive atmospheres (→ ATEX additional manual).

### 6.1 Preparing for commissioning

#### 6.1.1 Check downtimes

- ▶ Before starting up the pump, check the downtime and perform the following actions:
  - Check the fill level.
  - If the hydraulic parts are dirty, clean them.
  - Check that the impeller runs freely.

#### 6.1.2 Filling and bleeding

1. Open the suction-side fitting.
2. Open the pressure-side fitting.
3. Fill pump and suction pipe with fluid.
4. Verify that no pipe connections are leaking.

#### 6.1.3 Check direction of rotation

---

#### NOTE

---

#### Material damage as a result of dry running!

- ▶ Make sure the pump is filled properly.
1. Switch on motor for max. 2 seconds and switch it off again immediately.
  2. Visually check the direction of rotation of the motor fan impeller and make sure that the direction of rotation of the motor matches the direction arrow on the pump casing.
  3. If the sense of rotation is different: Change over the two phases (→ [5.5 Electrical connection, Page 14](#)).

## 6.2 Commissioning

### 6.2.1 Switching on

- ✓ Pump set up and connected properly
- ✓ Motor set up and connected properly
- ✓ All connections stress-free and sealed
- ✓ All safety equipment installed and tested for functionality
- ✓ Pump prepared, filled and vented correctly

---

#### NOTE

---

#### Risk of cavitation if suction flow is restricted!

- ▶ Open the suction-side fitting and do not use it to regulate the flow.
- ▶ Do not open the pressure-side fitting beyond the operating point.

---

#### NOTE

---

#### Material damage due to overheating!

- ▶ Do not operate the pump for long periods with the pressure-side fitting closed.
- ▶ Observe the minimum flow rate (→ [9.2.7 Flow rate, delivery head and minimum flow rate, Page 29](#)).

---

#### NOTE

---

#### Material damage as a result of dry running!

- ▶ Make sure the pump is filled properly.
1. Open the suction-side fitting.
  2. Close the pressure-side fitting.
  3. Switch on the motor and check it for smooth running.
  4. Once the motor has reached its nominal speed, open the pressure-side fitting slowly until the operating point is reached.
  5. Make sure temperature change is smaller than 5 K/min for pumps with hot fluids.
  6. After the initial stress due to the pressure and operating temperature, check that the pump is not leaking.
  7. If leaks are present at the casing seals or connection flanges, proceed as follows:
    - Switch off motor.
    - Close the control valves.
    - Remedy the leaks.

### 6.2.2 Switching off

- ✓ Pressure-side fitting closed (recommended)
1. Switch off motor.
  2. Check all connecting screws and tighten them to the specified torque (→ [9.2.6 Tightening torques of casing screws, Page 28](#)).

### 6.3 Shutting down the pump

- ▶ Take the following measures whenever the pump is shut down:

Pump is	Measure
shut down	▶ Take measures appropriate for the fluid (→ <a href="#">Tab. 5 Measures depending on the behavior of the pumped liquid, Page 16</a> ).
...emptied	▶ Close suction and pressure-side fitting.
...dismounted	▶ Isolate the motor from its power supply and secure it against unauthorized switch-on.
...put into storage	▶ Note measures for storage (→ <a href="#">4.2 Storage, Page 11</a> ).

Tab. 4 Measures to be taken if the pump is shut down

Behavior of the pumped liquid	Duration of shutdown (depending on process)	
	Short	Long
Crystallized or polymerized, solids sedimenting	▶ Flush the pump.	▶ Flush the pump.
Solidifying/ freezing, non-corrosive	▶ Heat up or empty the pump and containers.	▶ Empty the pump and containers.
Solidifying/ freezing, corrosive	▶ Heat up or empty the pump and containers.	▶ Empty the pump and containers.
Remains liquid, non-corrosive	–	–
Remains liquid, corrosive	–	▶ Empty the pump and containers.

Tab. 5 Measures depending on the behavior of the pumped liquid

### 6.4 Restoring the pump to service

- ▶ Complete all steps as for commissioning (→ [6.2 Commissioning, Page 15](#)).

### 6.5 Operating the stand-by pump

- ✓ Stand-by pump filled and bled

 Operate the stand-by pump at least once a week.

1. Fully open the suction-side fitting.
2. Open pressure-side fitting far enough so that the stand-by pump operating temperature is achieved and heating is even (→ [6.2.1 Switching on, Page 15](#)).

## 7 Maintenance

Opening the pump casing invalidates the warranty.

When used for the intended purpose the bearings and seals are virtually free of wear and will not require replacement during the warranty period.

Maintenance and repair work should be undertaken in consultation with Schmitt. The chapter describes maintenance not within the warranty period.

 For pumps in potentially explosive atmospheres (→ ATEX additional manual).

 Maintenance during the warranty period will be performed by Schmitt. Submit evidence of conveyed medium on request (DIN safety data sheet or confirmation of decontamination).

### 7.1 Inspections

 The inspection intervals depend on the operational strain on the pump.

1. Check at appropriate intervals:
  - Adherence to the minimum flow rate
  - Normal operating conditions unchanged
2. For trouble-free operation, always ensure the following:
  - No dry running
  - No leaks
  - No cavitation
  - Suction side open gate valves
  - Free and clean filters
  - Sufficient pump inlet pressure
  - No unusual running noises or vibrations
  - No parting of magnetic coupling

### 7.2 Servicing

 Plain bearings are subject to natural wear and tear which is heavily dependent on the respective operating conditions. It is therefore not possible to make general statements about the operating life.

#### 7.2.1 Maintenance in accordance with maintenance schedule

- ▶ Perform maintenance work in accordance with the maintenance schedule (→ [9.3 Maintenance schedule, Page 30](#)).

#### 7.2.2 Changing the plain bearings

 When changing the plain bearings, refer to the sectional drawing (→ [9.1.2 Drawing, Page 26](#)).

Request spare parts from the manufacturer (→ [7.4 Replacement parts and return, Page 19](#)).

When changing the plain bearings check the housing seal and impeller for damage, and if necessary replace them.

#### Disassembling the pump casing

To allow the plain bearings to be checked and replaced, disassemble the pump casing.

✓ Prepared for disassembly (→ [7.3.1 Preparations for dismounting, Page 18](#)).

1. Remove the hexagon nuts (43) and washers (42-3) from the hex-head bolts (27-3).
2. Remove the hex-head bolts (27-3) from the housing (06).
3. Remove the housing (06) from the rear cover (05).
4. Remove the housing seal (36) from the rear cover (05) and check it for damage. If necessary dispose of the housing seal and fit a new part.
5. Pull the impeller (04) off the rear cover (05).
6. Pull the rear cover (05) off the external magnet (07).

#### Check the plain bearings and replace them

#### NOTE

##### Material damage due to incorrect use!

- ▶ Disassemble and reassemble the ceramic parts of the plain bearings carefully; do not strike them or knock them.
- ▶ Note the correct sense of the thread:
  - Left-hand thread: Angle ring (11h), rear cover end
  - Right-hand thread: large angle ring (12v), housing end

7. Unscrew the angle rings (11h, 12v) from the impeller (04).
8. Check the impeller (04) for dirt and damage. If necessary clean the impeller or dispose of it, and fit a new part.
9. Check the angle rings (11h, 12v) for wear (→ [9.2.3 Wear limits, Page 27](#)). If the angle rings are worn, dispose of them and fit new parts.
10. Screw the angle rings (11h, 12v) finger-tight on to the impeller (04) as far as the stop.
11. Check the ring (13v) on the housing (06) for wear. If it is worn, completely dispose of the housing and the ring, and fit a new part.
12. Check the ring (10h) on the rear cover (05) for wear. If it is worn, completely dispose of the rear cover and the ring, and fit a new part.
13. If necessary, clear the through holes and relief holes.

### Assembling the pump casing

14. Make sure that the installation dimension **A** for the impeller (04) is correct (→ 9.2.4 Installation dimensions, Page 28).
15. Carefully insert the impeller (04) into the rear cover (05). When doing so, make sure that the ring (10h) is seated correctly on the angle ring (11h).
16. Insert the rear cover (05) together with the impeller (04) into the external magnet (07).
17. Insert the housing seal (36) into the groove on the des rear cover (05).
18. Assemble the housing (36) on to the rear cover (05). When doing so, make sure that the ring (13v) is seated correctly on the angle ring (12v).
19. Using the hex-head bolts (27-3), washers (42-3) and hexagon nuts (43), attach the housing (36) to the pump support (01). When doing so, tighten the nuts across diagonals and to the correct torque (→ 9.2.6 Tightening torques of casing screws, Page 28).
20. Spin the motor fan impeller and make sure that the impeller (04) runs freely in the plain bearings.

#### 7.2.3 Cleaning the pump

### NOTE

#### High water pressure or spray water can cause material damage!

- ▶ Do not direct water jets or steam jets into the opening of the flange.
- ▶ Regularly clean the pump to remove heavy dirt.

## 7.3 Dismounting

### ⚠ WARNING

#### Risk of injury due to heavy components!

- ▶ Pay attention to the component weight. Lift and transport heavy components using suitable lifting gear.
- ▶ Set down components safely and secure them against overturning or rolling away.

### ⚠ WARNING

#### Risk of injury during disassembly!

- ▶ Secure the pressure-side shut-off valve against accidental opening.
- ▶ Wear protective gloves, components can become very sharp-edged due to wear or damage.
- ▶ Observe the manufacturer's specifications (e.g. for the motor).

### NOTE

#### Material damage due to incorrect dismounting/installation of the pump!

- ▶ Only specialist mechanics should complete dismounting/installation work.

#### 7.3.1 Preparations for dismounting

- ✓ Pump is depressurized
  - ✓ Pump completely empty, flushed and decontaminated
  - ✓ Electrical connections disconnected and motor secured against switch-on
  - ✓ Pump cooled down
  - ✓ Pressure gauge lines, pressure gauge and fixtures dismounted
1. Dismantle the pipes on the suction and pressure side.
  2. Remove pump from the system.
  3. When dismounting, observe the following:
    - Mark the precise orientation and position of all components before dismounting them.
    - Dismount components concentrically without canting.

### 7.3.2 Dismount the pump

 Follow the section drawing for disassembly (→ 9.1.2 Drawing, Page 26).

---

#### NOTE

---

##### Material damage, fragile components!

- ▶ Perform disassembly carefully, and do not strike or knock the fragile ceramic parts of the plain bearing.
- ▶ Note the correct sense of the thread:
  - Left-hand thread: small angle ring, rear cover end
  - Right-hand thread: large angle ring, housing end

1. Remove the hexagon nuts (43) and washers (42-3) from the hex-head bolts (27-3).
2. Remove the hex-head bolts (27-3) from the housing (06).
3. Remove the housing (06) from the rear cover (05).
4. Remove the housing seal (36) from the rear cover (05).
5. Pull the impeller (04) off the rear cover (05).
6. Remove the angle rings (11h, 12v) from the impeller (04).
7. Pull the rear cover (05) off the external magnet (07).
8. If necessary, rotate the motor and pump support (01) into a suitable position that allows the external magnet (07) to be removed.
9. Rotate the external magnet (07) until the hexagon socket screw (09) at the opening of the pump support can be removed.
10. Unscrew the hexagon socket screw (09) from the external magnet (07).
11. Pull the external magnet (07) off the motor shaft.
12. Remove the hexagon socket screws (27) from the pump support (01).
13. Remove the pump support (01) from the motor.
14. Check that the through holes and relief holes are not blocked - if they are, clean them.

### 7.4 Replacement parts and return

1. Have the following information as shown on the name plate ready to hand when ordering spare parts (→ 3.1 Marking, Page 9).
  - Article numbers
  - Type
  - Year of manufacture
2. Please complete and enclose the confirmation of decontamination for returns (→ [www.schmitt-pumpen.de/sites/default/files/2020-10/Dekontaminationsnachweis\\_en.pdf](http://www.schmitt-pumpen.de/sites/default/files/2020-10/Dekontaminationsnachweis_en.pdf)).



3. Use only spare parts from SCHMITT (E-Mail: [sales@schmitt-pumpen.de](mailto:sales@schmitt-pumpen.de)).

## 7.5 Installing

 Install components concentrically and without tilting in accordance with the markings applied.

### WARNING

#### Risk of injury due to heavy components!

- ▶ Pay attention to the component weight. Lift and transport heavy components using suitable lifting gear.
- ▶ Set down components safely and secure them against overturning or rolling away.

### WARNING

#### Risk of injury during assembly!

- ▶ Observe the manufacturer's specifications (e.g. for the motor).

### NOTE

#### Material damage due to incorrect dismantling/installation of the pump!

- ▶ Only specialist mechanics should complete dismantling/installation work.

### NOTE

#### Material damage due to unsuitable components!

- ▶ Always replace lost or damaged screws with screws of the same strength where required.
- ▶ Only replace seals with seals of the same material.

### NOTE

#### Material damage, fragile components!

- ▶ Install ceramic parts of the plain bearing and magnets of the magnetic coupling with care, do not strike them or knock them.
- ▶ Note the correct sense of the thread:
  - Left-hand thread: small angle ring, rear cover end
  - Right-hand thread: large angle ring, housing end

### 7.5.1 Preparations for installation

- ▶ When installing please observe:
  - Replace worn parts with genuine spare parts.
  - Replace seals, inserting them in such a way that they are unable to rotate.
  - Do not apply synthetic or mineral oil, grease or cleaning agents to elastomer components.

### 7.5.2 Assembly of the pump

 Follow the section drawing for assembly (→ 9.1.2 Drawing, Page 26).

#### Preparing the impeller for installation

The impeller, angle rings, housing seal and rear cover are completely assembled as a unit, so as to avoid material damage during the following installation operations.

1. Make sure that the angle rings (11h, 12v) are not worn (→ 9.2.3 Wear limits, Page 27).
2. Screw the angle rings (11h, 12v) finger-tight on to the impeller (04) as far as the stop.
3. Make sure that the installation dimension **A** for the impeller (04) is correct (→ 9.2.4 Installation dimensions, Page 28).
4. Carefully insert the impeller (04) into the rear cover (05). When doing so, make sure that the ring (10h) is seated correctly on the angle ring (11h).
5. Insert the housing seal (36) into the groove on the des rear cover (05).
6. Put the unit safely aside.

#### Installing the pump

7. Align the pump support (01) with the opening in the motor foot.
8. Using the hexagon socket screws (27), attach the pump support (01) to the motor. When doing so, tighten the hexagon socket screws (27) across diagonals and to the correct torque (→ 9.2.6 Tightening torques of casing screws, Page 28).
9. If necessary, rotate the motor and pump support (01) into a suitable position that allows the external magnet (07) to be installed easily.
10. Rotate the motor shaft until the Woodruff key is aligned with the opening.
11. Align the external magnet (07) with the tapped hole for the hexagon socket screw (09) for the Woodruff key and slide it on to the motor shaft.
12. Adjust the external magnet (07) and pump support (01) to ensure the correct installation dimension **B** (→ 9.2.4 Installation dimensions, Page 28).
13. Screw in the hexagon socket screw (09) and secure the external magnet (07).
14. Check the correct installation dimension **B**.
15. Insert the unit of the rear cover (05) together with the impeller (04) into the external magnet (07).
16. Assemble the housing (36) on to the rear cover (05) and the impeller (04). When doing so, make sure that the ring (13v) is seated correctly on the angle ring (12v).
17. Using the hex-head bolts (27-3), washers (42-3) and hexagon nuts (43), attach the housing (36) to the pump support (01). When doing so, tighten the nuts across diagonals and to the correct torque (→ 9.2.6 Tightening torques of casing screws, Page 28).
18. Spin the motor fan impeller and make sure that the impeller (04) runs freely in the plain bearings.

### 7.5.3 Install the pump into the system

- ▶ Install the pump in the system.(→ [5 Disposal, Page 12](#)).

## 8 Troubleshooting

 For pumps in potentially explosive atmospheres (→ ATEX additional manual).

If faults occur which are not specified in the following table or cannot be traced back to the specified causes, please consult the manufacturer.

Possible faults are identified by a fault number in the table below. This number identifies the respective cause and remedy in the troubleshooting list.

Fault	Number
Pump not pumping	1
Pumping rate insufficient	2
Pumping rate excessive	3
Pumping pressure insufficient	4
Pumping pressure excessive	5
Pump running roughly / loud noises / vibration	6
Pump leaks	7
Excessive motor power uptake	8
Housing temperature too high	9

Tab. 6 Fault/number assignment

Fault number									Cause	Remedy
1	2	3	4	5	6	7	8	9		
X	-	-	-	-	-	-	-	-	Intake / suction pipe and/or pressure line closed by fitting	▶ Open the fitting.
X	-	-	-	-	-	-	-	-	Transport and sealing cover still in place	▶ Remove the transport and sealing cover. ▶ Dismount the pump and inspect it for dry-running damage.
X	X	-	X	-	-	-	-	-	Motor speed too low	▶ Compare the required motor speed with the specifications on the pump type plate. Replace the motor if necessary. ▶ Increase the motor speed if speed control is available.
X	X	-	X	-	-	-	-	-	Magnetic coupling has parted	▶ Switch off pump and switch on again.
X	X	-	X	-	X	-	-	-	Intake / suction pipe, pump or suction strainer blocked or encrusted	▶ Clean intake/suction pipe, pump or suction strainer.
X	X	-	X	-	X	-	-	-	Air is sucked in	▶ Seal source of problem.
X	X	-	X	-	X	-	-	-	Proportion of gas too high: pump is cavitating	▶ Consult the manufacturer.
X	X	-	X	-	X	-	-	-	Pump running in the wrong direction	▶ Change over any two phases in the motor.
X	X	-	X	-	X	-	-	-	Impeller out of balance or blocked	▶ Dismount the pump and inspect it for dry-running damage. ▶ Clean the impeller.
X	X	-	-	X	X	-	-	-	Pressure pipe blocked	▶ Clean the pressure pipe.

Fault number									Cause	Remedy
1	2	3	4	5	6	7	8	9		
X	-	-	-	-	X	-	-	-	Intake/suction pipe and pump not correctly vented or not completely filled	▶ Completely fill and vent pump and/or pipe.
X	-	-	-	-	X	-	-	-	Intake / suction pipe contains trapped air	▶ Install fitting for venting. ▶ Adjust piping installation.
X	-	-	-	-	-	-	-	X	Standstill, bearing rings stuck	▶ Disassemble the pump and carefully free the bearing rings.
-	X	-	X	-	-	-	-	-	Intake / suction pipe not completely open	▶ Open the fitting.
-	X	-	X	-	X	-	-	-	Cross section of intake / suction pipe too narrow	▶ Increase cross section. ▶ Clean encrustation from suction pipe. ▶ Fully open fitting.
-	X	-	X	-	X	-	-	-	Hydraulic parts of the pump dirty, clotted or encrusted	▶ Dismount the pump. ▶ Clean the parts.
-	X	-	X	-	X	-	-	-	Suction head too large: $NPSH_{\text{pump}}$ is larger than $NPSH_{\text{system}}$	▶ Increase pump inlet pressure. ▶ Consult the manufacturer.
-	X	-	X	-	X	-	-	-	Back pressure of the system is too high, pump selected is too small.	▶ Consult the manufacturer.
-	X	-	X	-	X	-	-	-	Pump parts worn	▶ Replace the worn pump parts.
-	X	-	X	-	X	-	-	-	Pump jammed	▶ Consult the manufacturer.
-	X	-	X	-	X	-	X	-	Motor running on 2 phases	▶ Check the fuse and replace it if necessary. ▶ Check the cable connections and insulation.
-	X	-	X	-	X	-	-	X	Temperature of fluid is too high: pump is cavitating	▶ Increase pump inlet pressure. ▶ Lower temperature. ▶ Contact the manufacturer.
-	X	-	X	-	-	-	X	X	Viscosity or specific gravity of the pumped liquid outside the range specified for the pump	▶ Consult the manufacturer.
-	X	-	X	-	-	-	-	X	Geodetic differential head and/or pipe flow resistances too high	▶ Remove sediments from the pump and/or pressure pipe. ▶ Install a larger impeller and consult the manufacturer. ▶ Reduce the system pressure.
-	X	-	-	X	X	-	-	-	Pressure-side fitting not opened wide enough	▶ Open the pressure-side fitting.
-	-	X	X	-	X	-	X	-	Pressure-side fitting opened too wide	▶ Throttle down at the pressure-side fitting. ▶ Machine the impeller down. Consult the manufacturer and adjust the impeller diameter.
-	-	X	-	X	-	-	-	-	Viscosity lower than expected	▶ Machine the impeller down. Consult the manufacturer and adjust the impeller diameter.

Fault number									Cause	Remedy
1	2	3	4	5	6	7	8	9		
-	-	X	-	X	X	-	X	-	Motor speed too high	<ul style="list-style-type: none"> <li>▶ Compare the required motor speed with the specifications on the pump type plate. Replace the motor if necessary.</li> <li>▶ Reduce the motor speed if speed control is available.</li> </ul>
-	-	X	-	X	X	-	X	-	Impeller diameter too large	<ul style="list-style-type: none"> <li>▶ Throttle down the flow rate at the pressure-side fitting. Observe the minimum flow rate.</li> <li>▶ Machine the impeller down. Consult the manufacturer and adjust the impeller diameter.</li> </ul>
-	-	X	-	-	X	-	X	-	Geodetic differential head, pipe flow resistances and/or other resistances lower than specified	<ul style="list-style-type: none"> <li>▶ Throttle down the flow rate at the pressure-side fitting. Observe the minimum flow rate.</li> <li>▶ Machine the impeller down. Consult the manufacturer and adjust the impeller diameter.</li> </ul>
-	-	-	-	-	X	X	X	-	Pump distorted	<ul style="list-style-type: none"> <li>▶ Check the pipe connections and pump attachment.</li> <li>▶ Check alignment of coupling.</li> <li>▶ Check attachment of the support foot.</li> </ul>
-	-	-	-	-	X	-	-	-	Pipes and fittings blocked	<ul style="list-style-type: none"> <li>▶ Disassemble and clean the pipes and fittings.</li> </ul>
-	-	-	-	-	X	-	X	-	Plain bearing faulty	<ul style="list-style-type: none"> <li>▶ Change the plain bearing (<a href="#">→ 7.2.2 Changing the plain bearings, Page 17</a>).</li> </ul>
-	-	-	-	-	-	X	-	-	Connecting bolts not correctly tightened	<ul style="list-style-type: none"> <li>▶ Check all connecting screws and tighten them to the specified torque (<a href="#">→ 9.2.6 Tightening torques of casing screws, Page 28</a>).</li> </ul>
-	-	-	-	-	-	X	-	-	Faulty housing seal	<ul style="list-style-type: none"> <li>▶ Replace the housing seal.</li> </ul>

Tab. 7 Troubleshooting list

## 9 Appendix

### 9.1 Replacement parts

#### 9.1.1 Part numbers and designations

Part no.	Designation
01	Pump support
04	Impeller
05	Rear cover
06	Housing
07	External magnet
09	Hexagon socket screw
10 h	Ring (rear cover)
11 h	Angle ring
12v	Angle ring
13v	Ring (housing)
27	Hexagon socket screw
27-3	Hexagon head bolt
36	Seal
42-3	Washer
43	Hexagon nut

Tab. 8 Designation of components according to part numbers

9.1.2 Drawing

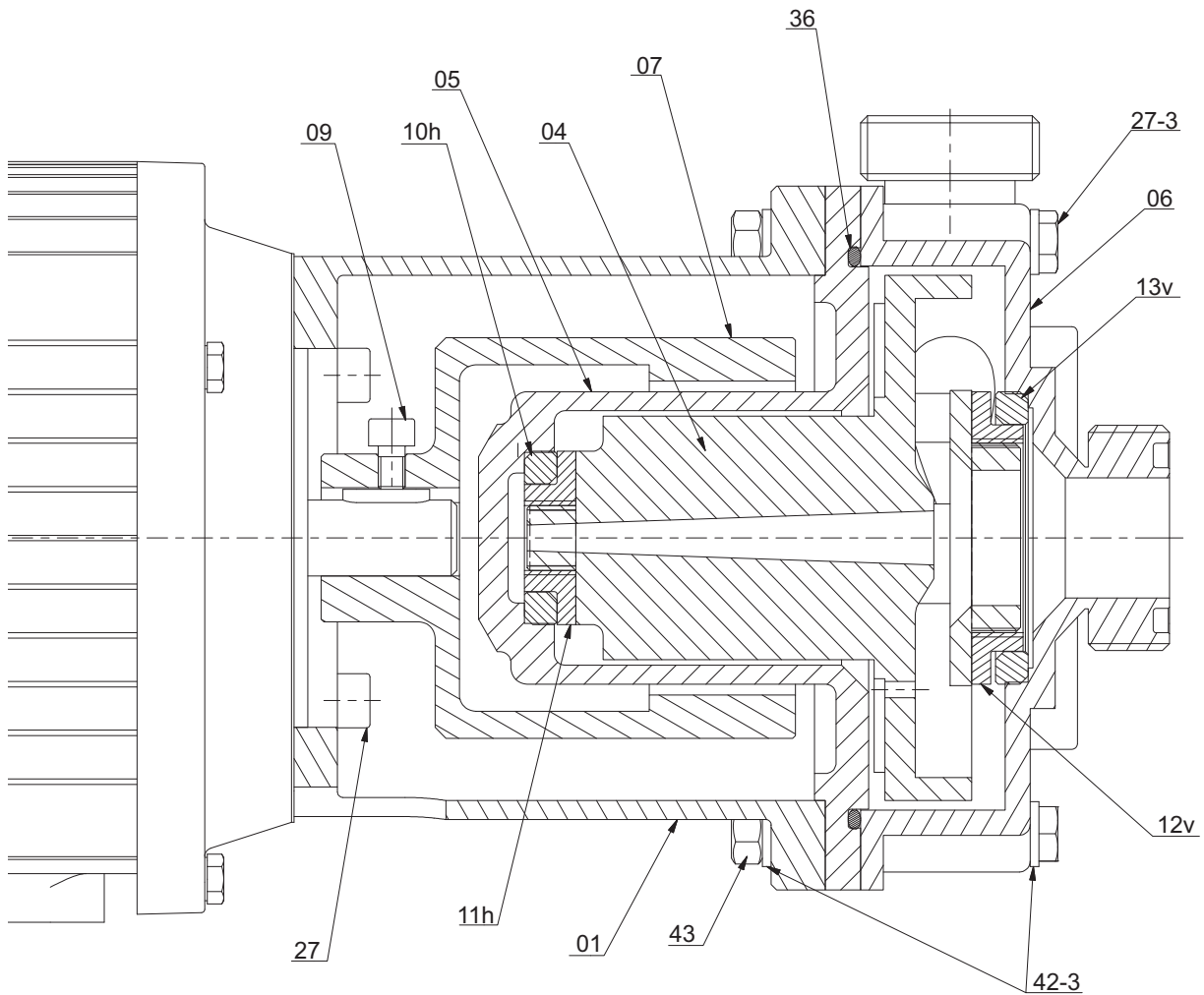



Fig. 6 Parts

## 9.2 Technical specifications

### 9.2.1 Ambient conditions

 Operation under any other ambient conditions should be agreed with the manufacturer.

Temperature [°C]	Relative humidity [%]		Installation height above sea level [m]
	Long-term	Short-term	
5 to +40 <sup>1)</sup>	≤ 85	≤ 100	≤ 1000

Tab. 9 Ambient conditions

1) material-dependent

### 9.2.2 Total pressure

 Total pressure = system pressure + pressure build-up in the pump

Max. permissible total pressure ( $p_t$ ) = 6 bar

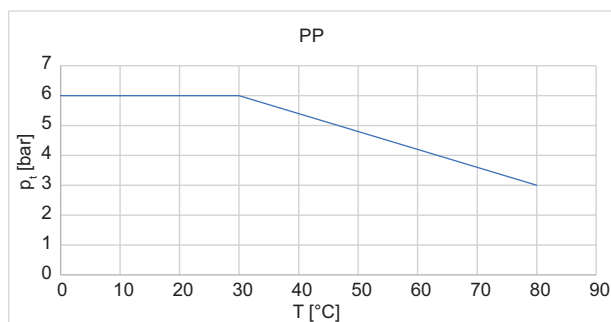

Fig. 7 Total pressure, pump head material PP

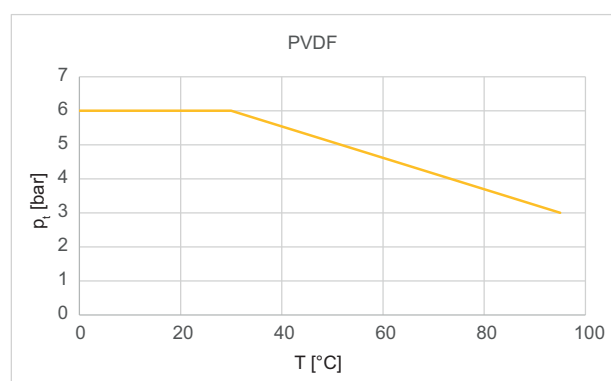



Fig. 8 Total pressure, pump head material PVDF

### 9.2.3 Wear limits

 The specified wear limits are indicative values.  
The angle rings must also be changed if the sliding faces are damaged, if for instance they exhibit deep grooves or unevenness.

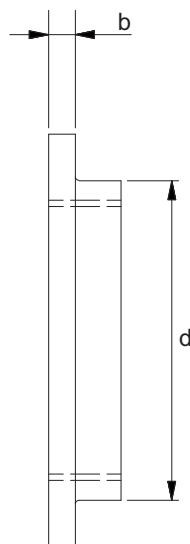

Fig. 9 Wear limits for the large angle ring (12v), housing end

b Thickness

d Diameter of the sliding face

MPN size ...	b		d	
	new [mm]	min. [mm]	new [mm]	min. [mm]
80	3.4	3.1	33.8	33.5
101–130	3.5	3.2	41.8	41.5
150–190	4	3.7	64.7	64.4

Tab. 10 Wear limits for the large angle ring, housing end

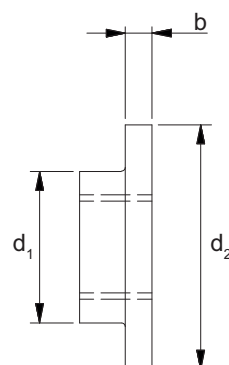

Fig. 10 Wear limits for the small angle ring (11h), rear cover end

b Thickness

$d_1$  Diameter of the sliding face

$d_2$  Overall diameter

MPN size ...	b		d <sub>1</sub>		d <sub>2</sub>
	new [mm]	min. [mm]	new [mm]	min. [mm]	new [mm]
80–130	3.5	3.2	19.8	19.5	32
150–190	4	3.7	33.8	33.5	45

Tab. 11 Wear limits for the small angle ring, rear cover end

### 9.2.4 Installation dimensions

The installation must comply with the following installation dimensions:

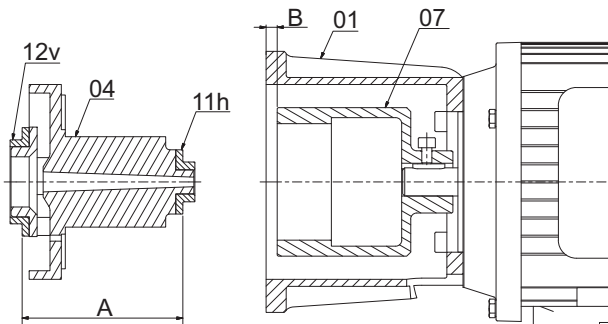

Fig. 11 Installation dimensions

A Impeller (04) and angle rings (12v, 11h)

B Pump support (01) and external magnet (07)

MPN size ...	A [mm]	B [mm]	Axial play [mm]
80	56.5	5.0	1.0
101	64.0	6.5	1.0
115	66.0	5.5	0.8
130	80.0	6.0	0.8
150	82.5	6.5	1.2
170	108.5	7.5	2.0
180H	109.0	7.0	2.0
190	109.0	7.0	2.0

Tab. 12 Installation dimensions

### 9.2.5 Sound pressure level

MPN size ...	Sound pressure level [db (A)]
80	57
101	53
115	60
130	62
150	68
170	78
190	80

Tab. 13 Sound pressure level

Measuring conditions:

- Distance to the pump: 1 m
- Operation: cavitating, gate valve fully open
- Tolerance  $\pm 3$  dB

### 9.2.6 Tightening torques of casing screws

Depending on the type of material of the pump, comply with the following tightening torques, and use a torque wrench:

MPN size ...	PVDF [Nm]	PP [Nm]
80	2	2
101	2	2
115	2	2
130	3	3
150	3	3
170	5	4
180H	7	6
190	7	6

Tab. 14 Tightening torques of casing screws

### 9.2.7 Flow rate, delivery head and minimum flow rate

The pump is operated within the following limits:

MPN size ...	Motor power rating [kw]	Flow rate		Max. differential head [m]	Minimum flow rate [m <sup>3</sup> /h]
		Qmin [m <sup>3</sup> /h]	Qmax [m <sup>3</sup> /h]		
80	0.18	0.06	2.8	4	0.2
101	0.18	0.06	5.4	6.6	0.3
115	0.25	0.08	8	11.5	0.3
130	0.55	0.17	11.5	13.5	0.4
150	1.1	0.4	19.3	17.6	0.5
170	2.2	0.7	22.7	26.1	0.6
180H	3.0	0.9	33	–	–
190	3.0	0.9	27.6	32.4	0.9

Tab. 15 Flow rate, delivery head and minimum flow rate

### 9.2.8 Weight

MPN size ...	Weight* [kg]
80	4
101	4
115	5
130	8
150	18
170	28
190	38

Tab. 16 Weight

\*) Weight depends on choice of material, immersion depth and motor design. All data are approximate values.

### 9.2.9 Cleaning agents

- Weakly alkaline soap solution
- Steam jet (only for individual parts)

### 9.3 Maintenance schedule

 The manufacture recommends shorter maintenance intervals if the medium being conveyed contains solid matter. The operating company should choose the maintenance intervals appropriate to the medium being conveyed.

Interval	Designation	Action
Daily	Conveyed fluid	<ul style="list-style-type: none"> <li>▶ Check temperature.</li> <li>▶ Check discharge pressure.</li> </ul>
Weekly	Operating temperatures	▶ Check motor temperature.
	Pump	▶ Check the pump for leaks and vibration.
Quarterly	Undoable screwed connections	▶ Check all connecting screws and tighten them to the specified torque (→ 9.2.6 Tightening torques of casing screws, Page 28).
	Plain bearing	<ul style="list-style-type: none"> <li>▶ Check the angle rings for wear (→ 9.2.3 Wear limits, Page 27). Change the angle rings if necessary.</li> <li>▶ Check the rings in the housing and rear cover for damage. If necessary change all the parts.</li> </ul>
	Impeller	<ul style="list-style-type: none"> <li>▶ Check the impeller for dirt and damage:               <ul style="list-style-type: none"> <li>– If the impeller is dirty, clean it.</li> <li>– If the impeller is damaged, replace it.</li> </ul> </li> </ul>
	Housing seal	▶ Visually check the housing seal for damage and change it if necessary.
As required	Motor	▶ Check the motor against the supplier's documentation and perform maintenance if necessary (→ 1.2 Other applicable documents, Page 4 ).

Tab. 17 Maintenance schedule

## 9.4 Declaration of conformity in accordance with EC machinery directive

### EU Declaration of Conformity



Manufacturer **SCHMITT-Kreiselpumpen GmbH & Co. KG**  
Einsteinstrasse 33  
D-76275 Ettlingen

Type of pump **Centrifugal pump**

Pump type **MPN 80, MPN 101, MPN 115, MPN 130, MPN 150, MPN 170, MPN 180H and MPN 190**

We declare that the design of the listed pumps satisfies the provisions of the EU Directives.  
The relevant points satisfy the requirements of the

EC Machinery Directive	<b>2006 / 42 / EC</b>
Low Voltage Directive	<b>2014 / 35 / EU</b>
Electromagnetic Compatibility	<b>2014 / 30 / EU</b>
Harmonized standards applied	<b>EN ISO 12100:2010 EN 809:1998+A1:2009+AC:2010</b>



Ettlingen, March 2025, **Moritz Klug**  
**Einsteinstrasse 33, 76275 Ettlingen**  
Managing Director / Documentation Officer  
SCHMITT-Kreiselpumpen GmbH & Co. KG